

# TERMOCUCINE LEGNA

Cooking stoves wood



catalogo 2023

Sistemi di riscaldamento a pellet e legna  
Heating pellet and wood system









# LINEA TERMOCUCINE



Nuova collezione di termocucine per il riscaldamento civile a legna: La Cucina è una percezione sensoriale.

È esperienza nel saper fare, è piacere nel creare, è gusto nel sentire, è aroma da odorare ed è bellezza da ammirare. NJOY Stove vi propone una gamma completa di prodotti ad alta efficienza, costruiti con elevati standard qualitativi, eleganti e moderni, fatti per essere inseriti in ogni spazio abitativo, dove qualità e stile si incontrano.

Qualità: produzione italiana controllata da personale qualificato. Tutti i componenti e i materiali utilizzati sono di origine europea e di prima qualità certificata e controllata. Selezionati dal nostro personale tecnico tra i migliori sul mercato.

New collection of cooking stoves for wood heating: the kitchen is a sensory perception.

It is experience in knowing how to do, it is pleasure in creating, it is taste in feeling, it is aroma to smell and it is beauty to be admired. NJOY offers you a complete range of high efficiency products, built with high quality standards, elegant and modern, made to be inserted in every living space, where quality and style meet.

Quality: Italian production controlled by qualified personnel. All components and materials used are of European origin and of certified and controlled quality. Selected by our technical staff among the best on the market.

# ESTER



Per riscaldare da 120 a 160 mq



ESTER è una termocucina in acciaio per il riscaldamento civile a legna: collegata all'impianto di idraulico vi riscalda tutta la casa oltre a cucinare sia sul piano cottura in ghisa che grazie all'ampio forno. Una termocucina senza tempo, ispirata da una lunga tradizione che si rinnova continuamente. Proposta in 5 modelli trattati con smalto e 1 in acciaio inox satinato, a garanzia di lunga durata.

ESTER is a steel cooking stove for wood heating: connected to the plumbing system, it heats the whole house as well as cooking both on the cast iron top and in the large oven. A timeless wood thermocooking stove, inspired by a long tradition that is continually renewed. Available in 5 models treated with enamel and 1 in satin stainless steel, to guarantee long life.



Potenza termica max / Max heating Power	13,5 Kw	24,8 Kw
Potenza termica nominale Nominal heating Power	11,8 Kw	19,6 Kw
Rendimento / Efficiency	87,4%	79,1 %
Consumo max / Consumption min/max	3,1 kg/h*	6,5 kg/h *
Capacità camera di combustione Combustion chamber capacity	fino a 15 kg	fino a 15 kg
Volume riscaldabile / Heatable volume	350 m <sup>3</sup> *	500 m <sup>3</sup> *
Contenuto d'acqua caldaia / Water content	26 lt	26 lt
Attacchi di mandata e ritorno Feed and return connections to heating system	1 1/4 "	1 1/4 "
Peso / Weight	250 kg	250 kg
Dimensione esterne LxHxD mm. External dimension WxHxD mm.	950x884x731	950x884x731
Diam. Uscita fumi / Smoke outlet diam	150 mm	150 mm
Certificazione ambientale	☆☆☆☆	☆

\* Variabile in base al tipo di legna ed alla pezzatura / Variable depending on the type of wood and the size



13,5  
kW

Potenza termica  
Heating power

25  
kW

Potenza termica  
Heating power



Acqua  
Water



Legna  
Wood



Forno  
Oven



Irraggiamento  
Radiant Heat



# ESTER



Inox  
Stainless steel



Bianco  
White



Cappuccino  
Cappuccino



Terra di Francia  
Earth of France



Rame brillante  
Brilliant copper



Canna di fucile  
Shotgun barrel



## Caratteristiche tecniche

- Termocucina a legna con finitura smaltata: garanzia di lunga durata nel tempo
- Maniglioni ottonati lucidi di serie (a richiesta disponibili anche in versione cromata)
- Finiture in acciaio inox satinato e lucido (contorno, distanziale, pannello frontale)
- Piano cottura in ghisa
- Forno di grandi dimensioni
- Uscita fumi di serie sia sopra che nella parte posteriore destra
- Rendimenti superiori al 79,1%
- Garanzia sul corpo caldaia di 3 anni
- Fornita di serie con centralina elettronica

## Technical Specification

- Wood heating stove with enamel finish: guarantee of long life
- Standard polished brass-plated handles (on request available also in chromed version)
- Satin and polished stainless steel finishes (contour, spacer, front panel)
- Cast iron cooking top
- Large oven
- Standard fumes outlet both above and in the rear right side
- Efficiency above 79.1%
- 3 year warranty on the boiler body

## Accessori

- Anello fumi in ghisa, attizzatore c/molla, manovella per l'alzagriglia

## Optional

- Coperchi termici isolati di colore smaltato molto apprezzati dai clienti poiché si riduce la dispersione dell'irraggiamento quando si intende privilegiare il circuito di riscaldamento; inoltre, le forme morbide e arrotondate ed il colore smaltato creano una perfetta armonia
- Fornita con kit per la produzione di acqua calda sanitaria
- Maniglioni cromati
- Versione con vista fuoco

## Accessories

- Cast iron flue ring, poker with spring, crank for grid lifting

## Optionals

- Insulated thermal lids of enamelled color greatly appreciated by customers since the dispersion of irradiation is reduced when the heating circuit is to be preferred; in addition, the soft and rounded shapes and the enamelled color create a perfect harmony.
- Supplied with kit for the production of domestic hot water
- Chromed handles
- Fire view version



13,5  
kW

Potenza termica  
Heating power

25  
kW

Potenza termica  
Heating power



Acqua  
Water



Legna  
Wood



Forno  
Oven



Irraggiamento  
Radiant Heat



Particolare maniglie ottonate  
Detail of brass-plated handles



1. Coperchio termico sinistro a richiesta
2. Coperchio termico destro a richiesta
3. Piano cottura in ghisa completo di serie di 5 cerchi
4. Termometro acqua diam. 52 con cassa in metallo
5. Pomolo regolazione piastra forno in acciaio inox satinato
6. Pannello frontale in acciaio inox lucido porta strumentazione
7. Forno smaltato completo di griglia cromata LxPxH 37x42x28 cm
8. Maniglie ottonate di grande pregio
9. Ampio cassetto porta legna apribile su guide scorrevoli
10. Sistema di sollevamento griglia in ghisa
11. Cassetto cenere estraibile
12. Regolatore automatico di tiraggio aria
13. Porta di caricamento legna in ghisa (apertura 25cm x 19cm)
14. Timer contaminuti

1. Left thermal cover on request
2. Right thermal cover on request
3. Cast iron hob complete with series of 5 circles
4. 52 mm water thermometer with metal case
5. Oven plate adjustment knob in brushed stainless steel
6. Polished stainless steel front panel with instrumentation
7. Large enamelled oven with chromed grid WxDxH 37x42x28 cm
8. Brass handles of great value
9. Large chest of drawers for opening wood on sliding guides
10. Cast iron grill lifting system
11. Removable ash drawer
12. Automatic air draft regulator
13. Cast iron wood loading door (opening 25cm x 19cm)
14. Timer

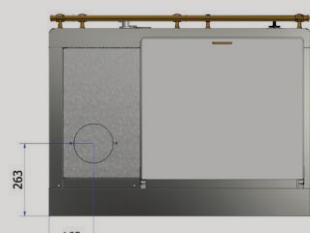
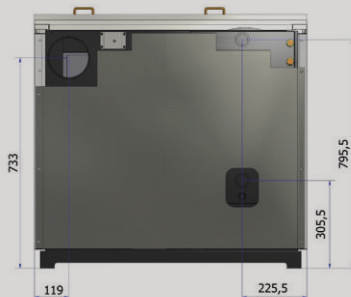
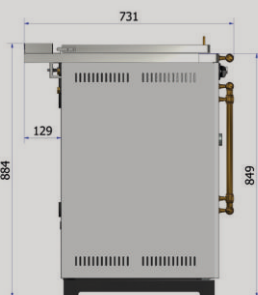

# ESTER



Linee senza tempo. Cucinare e riscaldarsi in modo naturale ed economico. Finiture eleganti e raffinate.

*Timeless lines. Cooking and heating in a natural and economic way. Elegant and refined finishes.*



13,5  
kW

Potenza termica  
Heating power

25  
kW

Potenza termica  
Heating power



Acqua  
Water



Legna  
Wood



Forno  
Oven



Irraggiamento  
Radiant Heat

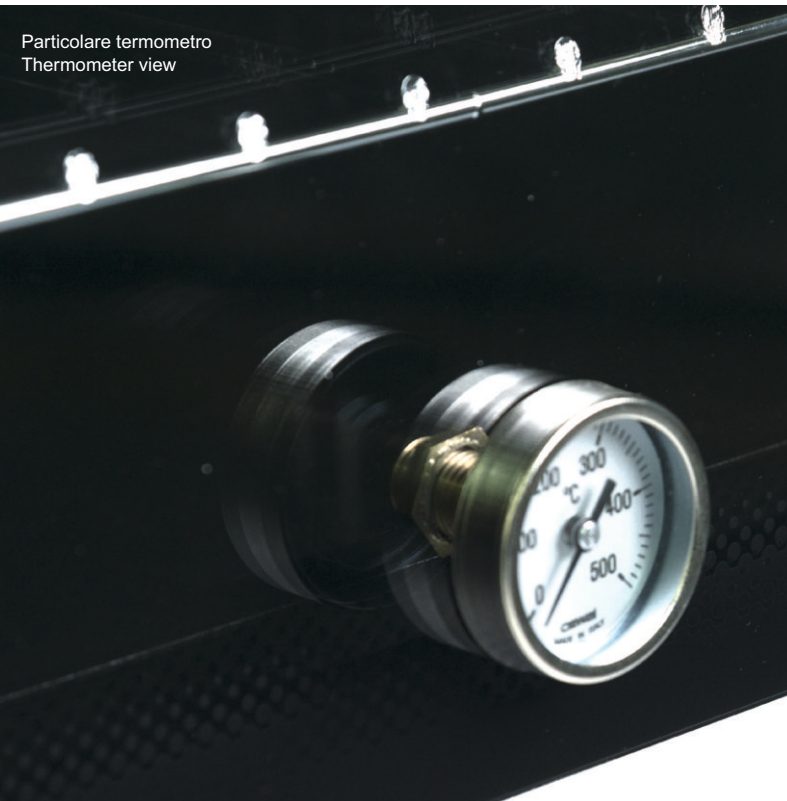

Particolare termometro  
Thermometer view



Particolare maniglie ottionate  
Detail of brass-plated handles



Particolare fronte termocucina aperta  
Detail of open cooking stove front

# JENNYFER



CASADEI è una termocucina in acciaio per il riscaldamento civile a legna: collegata all'impianto di idraulico vi riscalda tutta la casa oltre a cucinare sia sul piano cottura in ghisa che grazie all'ampio forno. Linee squadrate e moderne per questa versione con fianchi in acciaio inox satinato. Proposta in 3 modelli con frontale verniciato rosso oppure smaltato bianco e colore canna di fucile.

CASADEI is a steel cooking stove for wood heating: connected to the plumbing system, it heats the whole house as well as cooking both on the cast iron top and in the large oven.. Square and modern lines for this version with santin finished stainless steel sides. Available in 3 models with red painted front or white enamelled and gunmetal colour.

Potenza termica max / Max heating Power	13,5 Kw	24,8 Kw
Potenza termica nominale Nominal heating Power	11,8 Kw	19,6 Kw
Rendimento / Efficiency	87,4%	79,1 %
Consumo max / Consumption min/max	3,1 kg/h*	6,5 kg/h *
Capacità camera di combustione Combustion chamber capacity	fino a 15 kg	fino a 15 kg
Volume riscaldabile / Heatable volume	350 m <sup>3</sup> *	500 m <sup>3</sup> *
Contenuto d'acqua caldaia / Water content	26 lt	26 lt
Attacchi di mandata e ritorno Feed and return connections to heating system	1 1/4 "	1 1/4 "
Peso / Weight	250 kg	250 kg
Dimensione esterne LxHxD mm. External dimension WxHxD mm.	935x884x731	935x884x731
Diam. Uscita fumi / Smoke outlet diam	150 mm	150 mm
Certificazione ambientale	☆☆☆☆	☆



\* Variabile in base al tipo di legna ed alla pezzatura / Variable depending on the type of wood and the size



13,5  
kW

Potenza termica  
Heating power

25  
kW

Potenza termica  
Heating power



Acqua  
Water



Legna  
Wood



Forno  
Oven



Irraggiamento  
Radiant Heat



# JENNYFER



Bianca/Inox  
White/Inox



Rossa/Inox  
Red/Inox



Nero/Inox  
Black/Inox



## Caratteristiche tecniche

- Termocucina a legna con fianchi in acciaio inox e frontale smaltato bianco e canna di fucile; verniciato nella finitura rossa.
- Maniglioni cromati di serie
- Finiture in acciaio inox satinato e lucido (contorno, distanziale, pannello frontale)
- Piano cottura in ghisa
- Forno di grandi dimensioni
- Uscita fumi di serie sia sopra che nella parte posteriore destra
- Rendimenti fino al 79,1%
- Garanzia sul corpo caldaia di 3 anni
- Fornita di serie con centralina elettronica

## Accessori

- Anello fumi in ghisa, attizzatoio c/molla, manovella per l'alzagriglia

## Optional

- Coperchi termici isolati di colore smaltato molto apprezzati dai clienti poiché si riduce la dispersione dell'irraggiamento quando si intende privilegiare il circuito di riscaldamento; inoltre, le forme morbide e arrotondate ed il colore smaltato creano una perfetta armonia
- Fornita con kit per la produzione di acqua calda sanitaria
- Versione con vista fuoco

## Technical Specification

- Wood cooking stove with stainless steel sides and white and gunmetal enamel led front; red finish painting
- Chrome handles as standard
- Satin and polished stainless steel finishes (contour, spacer, front panel)
- Cast iron cooking top
- Large oven
- Standard fumes outlet both above and in the rear right side
- Efficiency above 79.1%
- 3 year warranty on the boiler body

## Accessories

- Cast iron flue ring, poker with spring, crank for grid lifting

## Optionals

- Insulated thermal lids in enamelled color greatly appreciated by customers since the dispersion of irradiation is reduced when the heating circuit is to be preferred; in addition, the soft and rounded shapes and the enamelled color create a perfect harmony.
- Supplied with kit for the production of domestic hot water
- Fire view version





13,5  
kW

Potenza termica  
Heating power

25  
kW

Potenza termica  
Heating power



Acqua  
Water



Legna  
Wood



Forno  
Oven



Irraggiamento  
Radiant Heat



Particolare pannello frontale termocucina Casadei  
Detail of the Casadei cooking stove front panel



1. Distanziale post inox
2. Cerchi piano cottura
3. Piano cottura in ghisa
4. Termometro acqua diam. 52 con cassa in metallo
5. Pomolo regolazione piastra forno in acciaio inox satinato
6. Pannello frontale in acciaio inox lucido porta strumentazione
7. Forno smaltato completo di griglia cromata LxPxH 37x42x28 cm
8. Maniglie ottonate di grande pregio
9. Ampio cassetto porta legna apribile su guide scorrevoli
10. Sistema di sollevamento griglia in ghisa
11. Cassetto cenere estraibile
12. Regolatore automatico di tiraggio aria
13. Porta di caricamento legna in ghisa (apertura 25cm x 19cm)
14. Timer contaminuti

1. Left thermal cover on request
2. Right thermal cover on request
3. Cast iron top
4. 52 mm water thermometer with metal case
5. Oven plate adjustment knob in brushed stainless steel
6. Polished stainless steel front panel with instrumentation
7. Large enamelled oven with chromed grid WxDxH 37x42x28 cm
8. Brass handles of great value
9. Large wood chest of drawer, opening on sliding guides
10. Cast iron grill lifting system
11. Removable ash drawer
12. Automatic air draft regulator
13. Cast iron wood loading door (opening 25cm x 19cm)
14. Timer

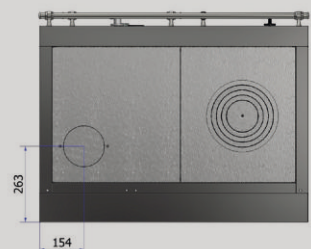
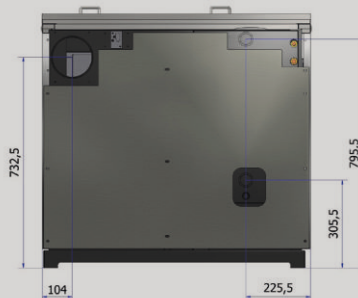
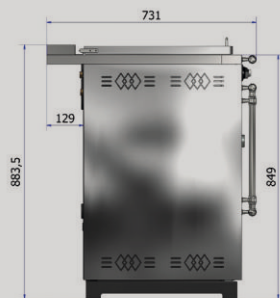

# JENNYFER



La tradizione incontra il gusto minimalista con i colori del rosso del bianco e del nero. Il tocco della vista della fiamma per godere appieno del piacere del fuoco acceso (a richiesta).

*Tradition meets minimal taste with the colors of red, white and black.  
The sight of the flame to fully enjoy the pleasure of the lit fire (on request).*



13,5  
kW

Potenza termica  
Heating power

25  
kW

Potenza termica  
Heating power



Acqua  
Water



Legna  
Wood



Forno  
Oven

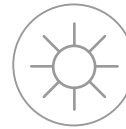

Irraggiamento  
Radiant Heat



Vista interna forno di cottura  
Inside view of cooking oven



Vista coperchi termici  
View of thermal lids

# ISABEL



CUKI 45 è una termocucina in acciaio per il riscaldamento civile a legna: collegata all'impianto di idraulico vi riscalda tutta la casa oltre a cucinare sul piano cottura in ghisa. Versione compatta senza forno. Una termocucina senza tempo, ispirata da una lunga tradizione che si rinnova continuamente. Proposta in 5 modelli trattati con smalto e 1 in acciaio inox satinato, a garanzia di lunga durata nel tempo.

CUKI 45 is a stainless steel cooking stove for wood heating: connected to the plumbing system, it heats the whole house as well as cooking on the cast iron top. Compact version without oven. A timeless wood cooking stove, inspired by a long tradition that is continually renewed. Available in 5 models treated with enamel and 1 in satin stainless steel, to guarantee long life.

Potenza termica max / Max heating Power	<b>21,6 Kw</b>
Potenza termica nominale Nominal heating Power	<b>17,4 Kw</b>
Rendimento / Efficiency	<b>80,6 %</b>
Consumo min/max / Consumption min/max	<b>2 - 8 *</b>
Capacità camera di combustione Combustion chamber capacity	<b>15 kg</b>
Volume riscaldabile / Heatable volume	<b>400 m<sup>3</sup> *</b>
Contenuto d'acqua caldaia / Water content	<b>25 lt</b>
Attacchi di mandata e ritorno Feed and return connections to heating system	<b>1 1/4 "</b>
Peso / Weight	<b>150 kg</b>
Dimensione esterne LxHxP mm. External dimension WxHxD mm.	<b>450x884x731</b>
Diam. Uscita fumi / Smoke outlet diam	<b>150 mm</b>
<b>Certificazione ambientale</b>	<b>☆</b>



\* Variabile in base al tipo di legna ed alla pezzatura / Variable depending on the type of wood and the size  
Dati provvisori in corso di certificazione / Provisional data pending certification



21  
kW

Potenza termica  
Heating power



Acqua  
Water



Legna  
Wood



Irraggiamento  
Radiant Heat



# ISABEL



Inox  
Stainless steel



Bianco  
White



Cappuccino  
Cappuccino



Terra di Francia  
Earth of France



Rame brillante  
Brilliant copper



Canna di fucile  
Shotgun barrel



## Caratteristiche tecniche

- Termocucina a legna con fianchi in acciaio inox e frontale smaltato bianco e canna di fucile; verniciato nella finitura rossa
- Maniglioni cromati di serie
- Finiture in acciaio inox satinato e lucido (contorno, distanziale, pannello frontale)
- Piano cottura in ghisa
- Uscita fumi superiore
- Rendimenti superiori al 80%
- Garanzia sul corpo caldaia di 3 anni
- Fornita di serie con centralina elettronica

## Accessori

- Anello fumi in ghisa, attizzatoio c/molla, manovella per l'alzagriglia, centralina elettronica

## Optional

- Fornita con kit per la produzione di acqua calda sanitaria
- Maniglioni cromati
- Versione con vista fuoco

## Technical Specification

- Wood heating cooker with stainless steel sides and white and gunmetal enamelled front; red finish painting
- Chrome handles as standard
- Satin and polished stainless steel finishes (contour, spacer, front panel)
- Cast iron cooking top
- Upper fume outlet
- Efficiency above 80%
- 3 year warranty on the boiler body

## Accessories

- Cast iron flue ring, poker with spring, crank for grid lifting, electronic control unit

## Optionals

- Supplied with kit for the production of domestic hot water
- Chromed handles
- Fire view version





21  
kW

Potenza termica  
Heating power



Acqua  
Water



Legna  
Wood



Irraggiamento  
Radiant Heat



Vista particolare contorno inox satinato  
Detail of satin stainless steel outline

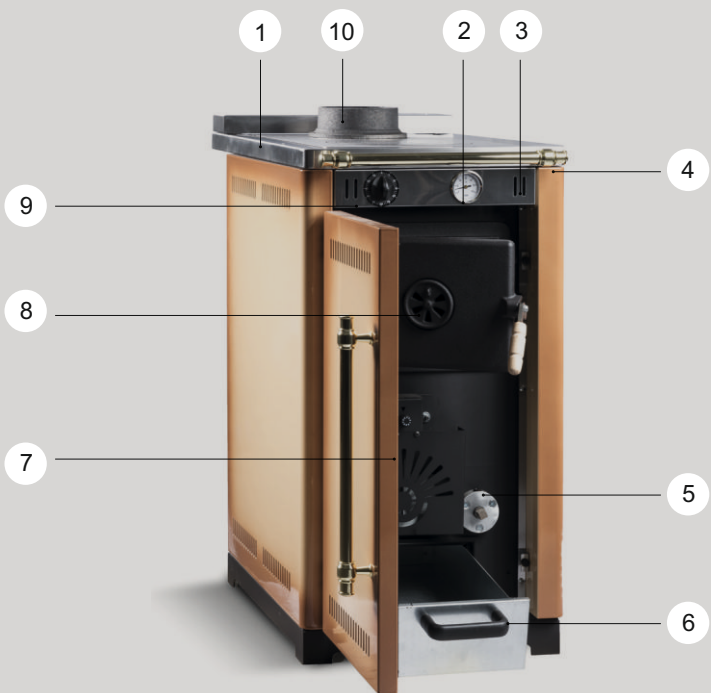

1. Piano cottura in ghisa completo di serie di 5 cerchi
2. Termometro acqua diam. 52 con cassa in metallo
3. Pannello frontale in acciaio inox lucido porta strumentazione
4. Maniglie ottonate di grande pregio
5. Sistema di sollevamento griglia in ghisa
6. Cassetto cenere estraibile
7. Regolatore automatico di tiraggio aria
8. Porta di caricamento legna in ghisa (apertura 25cm x 19 cm)
9. Timer contaminuti
10. Uscita fumi superiore d.150 mm

1. Cast iron hob complete with 5 rings
2. 52 mm water thermometer with metal case
3. Polished stainless steel front panel with instrumentation
4. Brass handles of great value
5. Cast iron grill lifting system
6. Removable ash drawer
7. Automatic air draft regulator
8. Cast iron wood loading door (opening 25cm x 19cm)
9. Timer
10. Upper fume outlet (diametre 15cm)

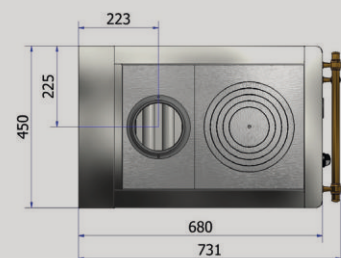
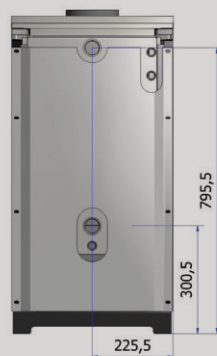
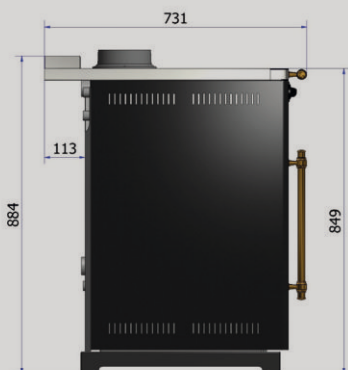

# I S A B E L



Linee senza tempo. Cucinare e riscaldarsi in modo naturale ed economico. Una termocucina a legna in soli 45 cm

*Timeless lines. Cooking and heating in a natural and economic way.  
A wood cooking stove in just 45 cm*



21  
kW

Potenza termica  
Heating power



Acqua  
Water



Legna  
Wood



Irraggiamento  
Radiant Heat



Termometro d.52  
Thermometer d. 52

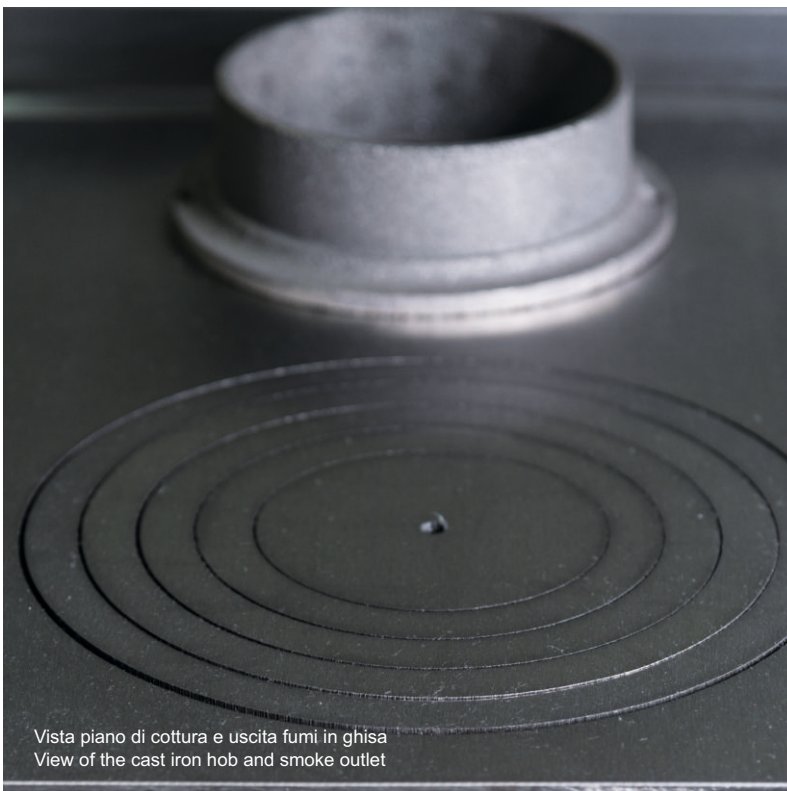

Vista piano di cottura e uscita fumi in ghisa  
View of the cast iron hob and smoke outlet



Regolatore automatico di tiraggio  
Automatic draft regulator

# DIANA



VIKI 45 è una termocucina in acciaio per il riscaldamento civile a legna: collegata all'impianto idraulico vi riscalda tutta la casa oltre a cucinare sul piano cottura in ghisa. Versione compatta senza forno. Linee squadrate e moderne per questa versione con fianchi in acciaio inox satinato. Proposta in 3 modelli con frontale verniciato rosso oppure smaltato bianco e colore canna di fucile.

VIKI 45 is a steel heating stove for wood heating: connected to the plumbing system, it heats the whole house. Cooking is possible on the cast iron hob. Compact version without oven. Modern lines with glazed stainless steel sides. Available in 3 models with red coated or white enameled front side and burnished colour.

Potenza termica max / Max heating Power	<b>21,6 Kw</b>
Potenza termica nominale Nominal heating Power	<b>17,4 Kw</b>
Rendimento / Efficiency	<b>80,6 %</b>
Consumo min/max / Consumption min/max	<b>2 - 8 *</b>
Capacità camera di combustione Combustion chamber capacity	<b>15 kg</b>
Volume riscaldabile / Heatable volume	<b>400 m<sup>3</sup> *</b>
Contenuto d'acqua caldaia / Water content	<b>25 lt</b>
Attacchi di mandata e ritorno Feed and return connections to heating system	<b>1 1/4 "</b>
Peso / Weight	<b>150 kg</b>
Dimensione esterne LxHxD mm. External dimension WxHxD mm.	<b>450 x 884 x 731</b>
Diam. Uscita fumi / Smoke outlet diam	<b>150 mm</b>
<b>Certificazione ambientale</b>	<b>☆</b>



\* Variabile in base al tipo di legna ed alla pezzatura / Variable depending on the type of wood and the size  
Dati provvisori in corso di certificazione / Provisional data pending certification



21  
kW

Potenza termica  
Heating power



Acqua  
Water



Legna  
Wood



Irraggiamento  
Radiant Heat



# DIANA



Bianca/Inox  
White/Inox



Rossa/Inox  
Red/Inox



Nero/Inox  
Black/Inox



## Caratteristiche tecniche

- Termocucina a legna con finitura smaltata: garanzia di lunga durata nel tempo
- Maniglioni cromati
- Finiture in acciaio inox satinato e lucido (contorno, distanziale, pannello frontale)
- Piano cottura in ghisa
- Uscita fumi superiore
- Rendimenti fino al 80%
- Garanzia sul corpo caldaia di 3 anni
- Fornita di serie con centralina elettronica

## Accessori

- Anello fumi in ghisa, attizzatore c/molla, manovella per l'alzagriglia, centralina elettronica

## Optional

- Fornita con kit per la produzione di acqua calda sanitaria
- Versione con vista fuoco

---

## Technical Specification

- Wood heating stove with enamel finish: guarantee of long life over time
- Chromed handles
- Satin and polished stainless steel finishes (contour, spacer, front panel)
- Cast iron cooking top
- Upper fume outlet
- Efficiency up to 80%
- 3 year warranty on the boiler body

## Accessories

- Cast iron flue ring, poker with spring, crank for grill, electronic control unit

## Optionals

- Supplied with kit for the production of domestic hot water
- Fire view version



**21**  
kW

Potenza termica  
Heating power



Acqua  
Water



Legna  
Wood



Irraggiamento  
Radiant Heat

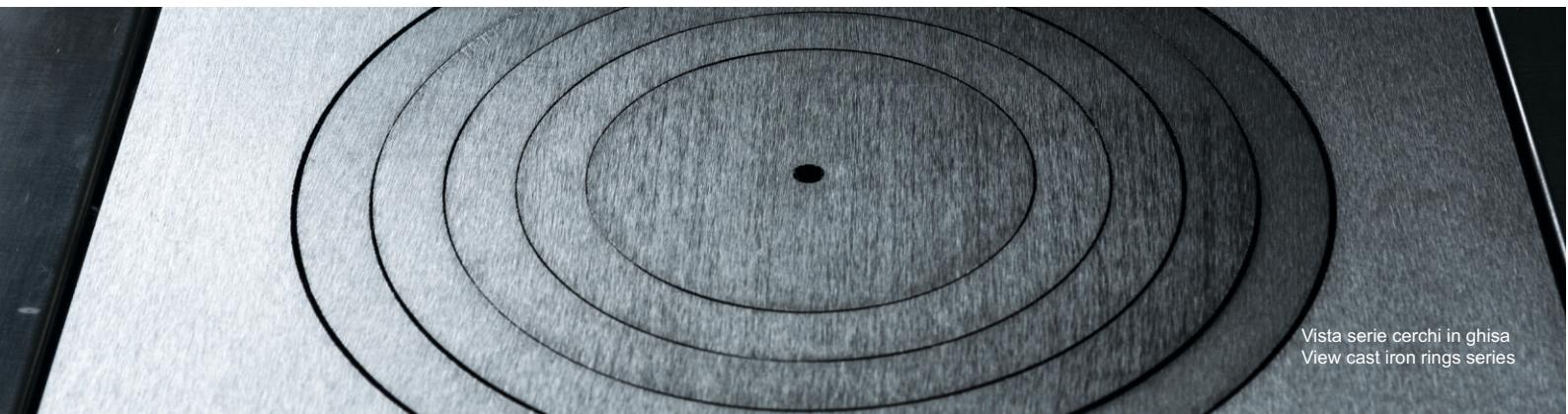

Vista serie cerchi in ghisa  
View cast iron rings series



1. Piano cottura in ghisa completo di serie di 5 cerchi
2. Termometro acqua diam. 52 con cassa in metallo
3. Pannello frontale in acciaio inox lucido porta strumentazione
4. Maniglie ottonate di grande pregio
5. Sistema di sollevamento griglia in ghisa
6. Cassetto cenere estraibile
7. Regolatore automatico di tiraggio aria
8. Porta di caricamento legna in ghisa (apertura 25cm x 19cm)
9. Timer contaminuti
10. Uscita fumi superiore d.150 mm

1. Cast iron hob complete with 5 standard rings
2. 52 mm water thermometer with metal case
3. Polished stainless steel front panel
4. Brass handles
5. Cast iron grill lifting system
6. Removable ash drawer
7. Automatic air draft regulation
8. Cast iron wood loading door (opening 25cm x 19cm)
9. Timer
10. Upper fume outlet (diameter 15cm)

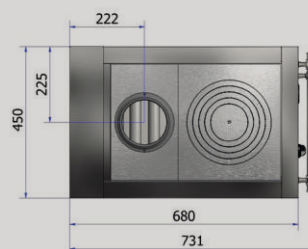
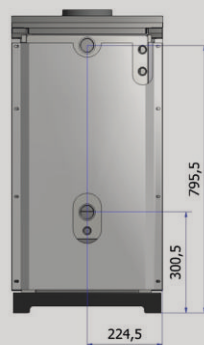
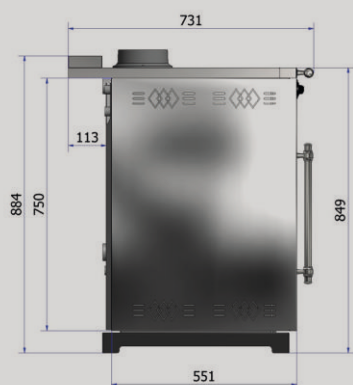



# D I A N A



La tradizione incontra il gusto minimalista con i colori del rosso del bianco e del nero. Il tocco della vista della fiamma per godere appieno del piacere del fuoco acceso (a richiesta).

*Tradition meets minimalist taste with the colors red, white and black.  
View of the flame to fully enjoy the pleasure of the fire (upon request)*

21  
kW

Potenza termica  
Heating power



Acqua  
Water



Legna  
Wood



Irraggiamento  
Radiant Heat

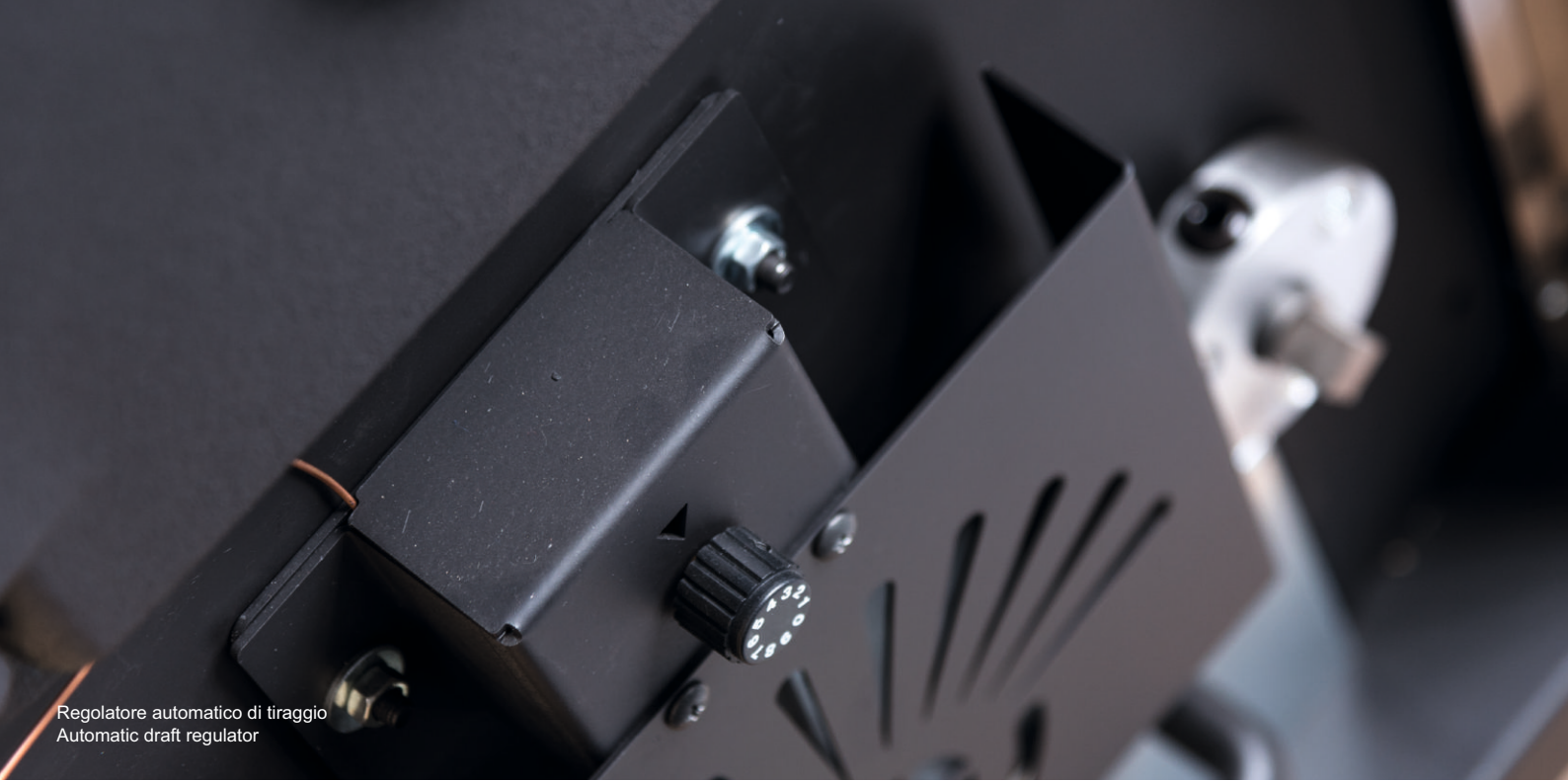

Regolatore automatico di tiraggio  
Automatic draft regulator



Termometro d.52  
Thermometer d. 52

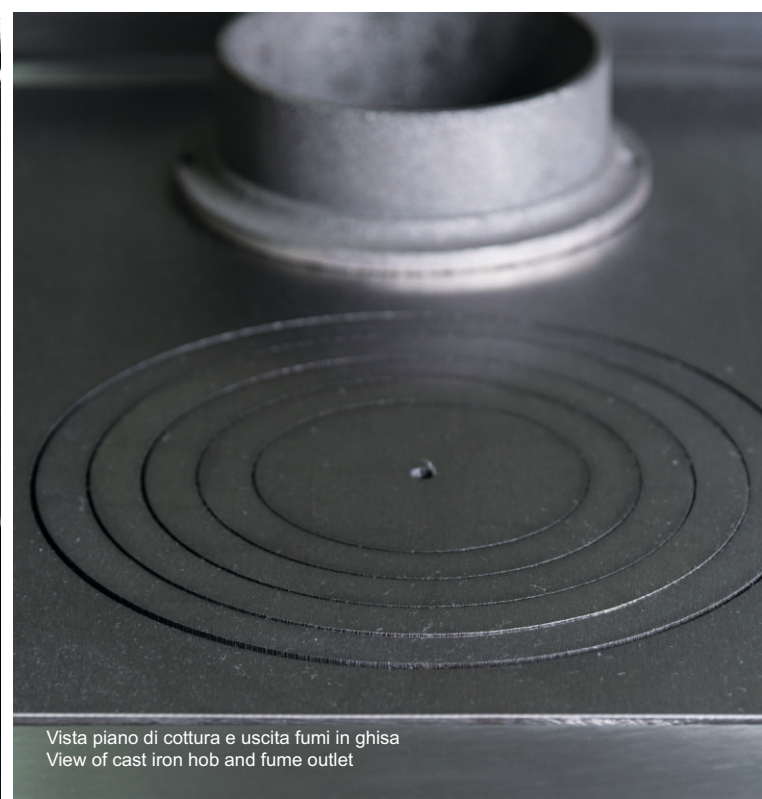

Vista piano di cottura e uscita fumi in ghisa  
View of cast iron hob and fume outlet

# DOROTEA



DOROTEA è una termocucina in acciaio per il riscaldamento civile a legna: collegata all'impianto di idraulico vi riscalda tutta la casa oltre a cucinare sia sul piano cottura in ghisa che grazie all'ampio forno. Linee squadrate e moderne per questa versione con fianchi in acciaio inox satinato. Proposta in 3 modelli con frontale verniciato rosso oppure smaltato bianco e colore canna di fucile.

DOROTEA is a stainless steel cooking stove for wood heating: connected to the plumbing system, it heats the whole house. Cooking is possible on the cast iron hob and with the large oven. Modern lines with satin stainless steel sides Available in 3 models with red coated or white enameled front, burnished colour.

Potenza termica max / Max heating Power	13,5 Kw	24,8 Kw
Potenza termica nominale Nominal heating Power	11,8 Kw	19,6 Kw
Rendimento / Efficiency	87,4%	79,1 %
Consumo max / Consumption min/max	3,1 kg/h*	6,5 kg/h *
Capacità camera di combustione Combustion chamber capacity	fino a 15 kg	fino a 15 kg
Volume riscaldabile / Heatable volume	350 m <sup>3</sup> *	500 m <sup>3</sup> *
Contenuto d'acqua caldaia / Water content	26 lt	26 lt
Attacchi di mandata e ritorno Feed and return connections to heating system	1 1/4 "	1 1/4 "
Peso / Weight	240 kg	240 kg
Dimensione esterne LxHxD mm. External dimension WxHxD mm.	850x884x728	850x884x728
Diam. Uscita fumi / Smoke outlet diam	150 mm	150 mm
Certificazione ambientale	☆☆☆☆	☆



\* Variabile in base al tipo di legna ed alla pezzatura / Variable depending on the type of wood and the size



13,5  
kW

Potenza termica  
Heating power

25  
kW

Potenza termica  
Heating power



Acqua  
Water



Legna  
Wood



Forno  
Oven

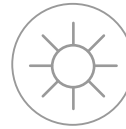

Irraggiamento  
Radiant Heat



# DOROTEA



Bianca/Inox  
White/Inox



Nero/Inox  
Black/Inox



Rossa/Inox  
Red/Inox



## Caratteristiche tecniche

- Termocucina a legna con fianchi in acciaio inox e frontale smaltato bianco e canna di fucile; verniciato nella finitura rossa.
- Maniglioni cromati di serie
- Finiture in acciaio inox satinato e lucido (contorno, distanziale, pannello frontale)
- Piano cottura in ghisa
- Forno
- Uscita fumi di serie sia sopra che nella parte posteriore destra
- Rendimenti fino al 79,1%
- Garanzia sul corpo caldaia di 3 anni
- Fornita di serie con centralina elettronica

## Accessori

- Anello fumi in ghisa, attizzatoio c/molla, manovella per l'alzagriglia

## Optional

- Coperchio termico isolato di colore smaltato molto apprezzato dai clienti poiché si riduce la dispersione dell'irraggiamento quando si intende privilegiare il circuito di riscaldamento; inoltre, le forme morbide e arrotondate ed il colore smaltato creano una perfetta armonia
- Fornita con kit per la produzione di acqua calda sanitaria
- Versione con vista fuoco

## Technical Specification

- Wood cooking stove with stainless steel sides and white and burnished enameled front; red finish
- Chrome handles, standard
- Satin and polished stainless steel finishes (contour, spacer, front panel)
- Cast iron cooking top
- Oven
- Standard fume outlet, above and on the rear right side
- Efficiency up to 79.1%
- 3 year warranty on the boiler body

## Accessories

- Cast iron fume ring, poker with spring, crank for grill

## Optionals

- Insulated thermal cover, enameled, appreciated by customers as the radiance dispersion is low when the heating circuit is to be preferred; furthermore, the soft and rounded shapes and the enameled color create a perfect harmony.
- Supplied with kit for the production of domestic hot water
- Fire view version



13,5  
kW

Potenza termica  
Heating power

25  
kW

Potenza termica  
Heating power



Acqua  
Water



Legna  
Wood



Forno  
Oven



Irraggiamento  
Radiant Heat

Vista termocucina aperta  
Cooking stove internal view

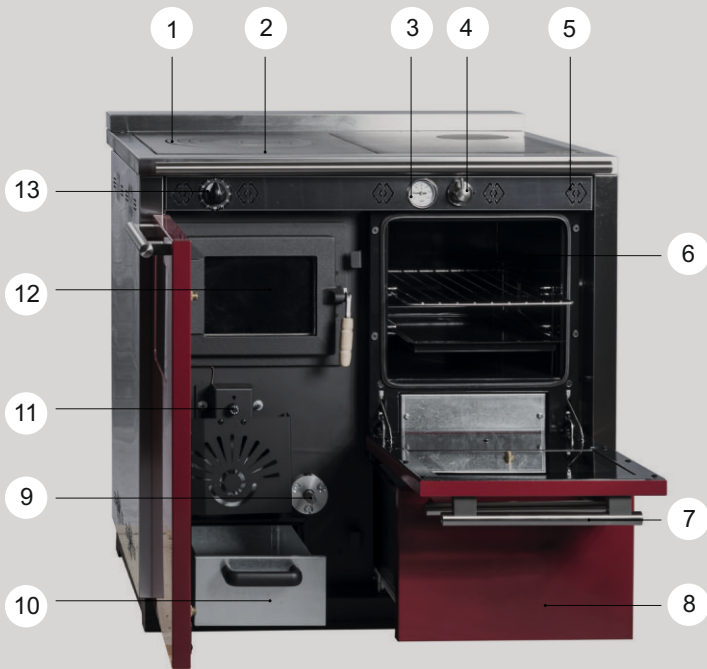

1. Distanziale post inox
2. Cerchi piano cottura di serie di 5 cerchi
3. Termometro acqua diam. 52 con cassa in metallo
4. Pomolo regolazione piastra forno in acciaio inox satinato
5. Pannello frontale in acciaio inox lucido portastrumentazione
6. Forno smaltato di grandi dimensioni completo di griglia cromata LxPxH 31x42x28 cm
7. Maniglie ottonate di grande pregio (a richiesta cromo)
8. Ampio cassetto porta legna apribile su guide scorrevoli
9. Sistema di sollevamento griglia in ghisa
10. Cassetto cenere estraibile
11. Regolatore automatico di tiraggio aria
12. Porta di caricamento legna in ghisa (apertura 25cm x 19cm)
13. Timer contaminuti

1. Rear stainless steel spacer
2. Series of 5 rings on cooktop
3. 52 mm water thermometer with metal case
4. Oven plate adjustment knob in satin stainless steel
5. Polished stainless steel front panel
6. Large enamelled oven with chromed grid WxDxH 37x42x28 cm
7. Brass handles (chrome upon request)
8. Large wood drawer, opening on sliding guides
9. Cast iron grid lifting system
10. Removable ash drawer
11. Automatic air draft regulation
12. Cast iron wood loading door (opening 25cm x19cm)
13. Timer

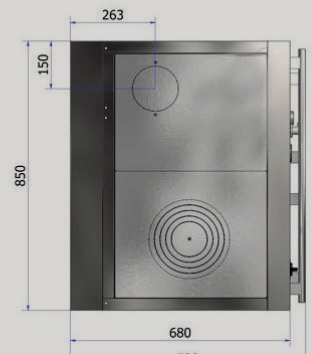
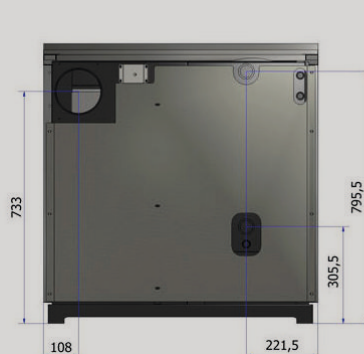
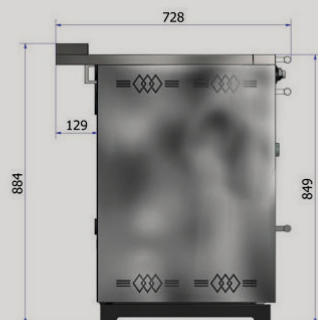



# DOROTEA



La tradizione incontra il gusto minimalista con i colori del rosso del bianco e del nero. Il tocco della vista della fiamma per godere appieno del piacere del fuoco acceso (a richiesta).

*Tradition meets minimalist taste with the colors red, white and black.  
View of the flame to fully enjoy the pleasure of the fire (upon request).*

13,5  
kW

Potenza termica  
Heating power

25  
kW

Potenza termica  
Heating power



Acqua  
Water



Legna  
Wood



Forno  
Oven



Irraggiamento  
Radiant Heat



Interno termocucina Logan  
Logan cooking stove internal view













Particolare maniglia alluminio satinato  
Detail of satin aluminum handle

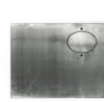
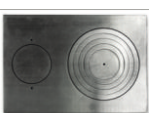

# ACCESSORI TERMOCUCINE

	<b>AC-0039</b>	<b>Contaminuti per frontale termocucina</b> <i>Timer for cooking Stove front</i>
	<b>AC-0040</b>	<b>Manopola nera contaminuti</b> <i>Black timer knob</i>
	<b>AC-0043</b>	<b>Manopola regolaz.fumi piastra/forno ACCIAIO INOX</b> <i>Plate/oven fume regulation knob STAINLESS STEEL</i>
	<b>AC-0190</b>	<b>Asta completa regolazione fumi Termocucina c/forno</b> <i>Complete fume control rod Cooker with oven</i>
	<b>AC-0044</b>	<b>Cassetto cenere per termocucine 200x400</b> <i>Ash drawer for cookers 225x400</i>
	<b>AC-0046</b>	<b>Guarnizione treccia tricotex diam. 10</b> <i>Tricotex braid gasket diam. 10</i>
	<b>AC-0048</b>	<b>Guarnizione treccia tricotex diam. 14 nera</b> <i>Tricotex braid gasket diam. 14 black</i>
	<b>AC-0050</b>	<b>Guarnizione treccia tricotex diam. 20x20</b> <i>Tricotex braid gasket diam. 20x20</i>
	<b>AC-0051</b>	<b>Guarnizione treccia vetro rigida 12x12</b> <i>Rigid glass braid gasket diam. 12x12</i>
	<b>AC-0053</b>	<b>Guarnizione forno termocucina CUKI 95 - CASADEI</b> <i>Cooker oven gasket CUKI 95 - CASADEI</i>
	<b>AC-0027</b>	<b>Guarnizione forno termocucina CUKI 85 - LOGAN</b> <i>Cooker oven gasket CUKI 85 - LOGAN</i>
	<b>AC-0054</b>	<b>Termometro acqua Ø52 per termocucine</b> <i>Water thermometer Ø52 for cooking stove</i>
	<b>AC-0055</b>	<b>Termometro Ø40 per forno termocucine</b> <i>Ø 40 thermometer for cooker oven</i>

	<b>AC-0056</b>	<b>Termoregolatore per termocucine</b> <i>Thermoregulator for cooking stove</i>
	<b>AC-0057</b>	<b>Manopola per Termoregolatore</b> <i>Thermoregulator knob</i>
	<b>AC-0058</b>	<b>Scatola supporto Termoregolatore</b> <i>Thermoregulator support box</i>
	<b>AC-0060</b>	<b>Anello fumi d. 150 ghisa</b> <i>Smoke ring d. 150 cast iron</i>
	<b>AC-0061</b>	<b>Griglia in ghisa per termocucine 360X282</b> <i>Cast iron grid for cooker 360X282</i>
	<b>AC-0062</b>	<b>Piastra cerchi SX per termocucina 470X420</b> <i>Left ring plate for cooker 470X420</i>
	<b>AC-0063</b>	<b>Piastra fumi dx per termocucina 470X445 (Cuki 95 - Casadei)</b> <i>Right fume plate for cooker 470X445 (Cuki 95 - Casadei)</i>
	<b>AC-0028</b>	<b>Piastra fumi dx per termocucina 470X370 (Logan)</b> <i>Right fume plate for cooker 470X370 (Logan)</i>
	<b>AC-0026</b>	<b>Piastra ghisa intera cerchi 345X504 Cuki - Viki 45</b> <i>Full cast iron plate for rings 345X504 Cuki - Viki 45</i>
	<b>AC-0068</b>	<b>Serie 5 cerchi in ghisa d. 250 Cuki 45</b> <i>5 cast iron rings d. 250 Cuki 45</i>
	<b>AC-0069</b>	<b>Portina CIECA con valvola completa in ghisa</b> <i>Complete cast iron door with valve</i>
	<b>AC-0097</b>	<b>Portina in ghisa completa VISTA FUOCO</b> <i>Cast iron door complete with FIRE VIEW</i>
	<b>AC-0073</b>	<b>Circolatore alta efficienza 15/50 int. 130mm 1"</b> <i>High efficiency circulator 15/50 int. 130mm 1"</i>

	<b>AC-0148</b>	<b>Scambiatore a piastre ZB-24P</b> PIASTRE INOX <i>Plate heat exchanger ZB-24P STAINLESS STEEL PLATES</i>
	<b>AC-0296</b>	Centralina per Termocucina <i>Control unit for cooker</i>
	<b>AC-0077</b>	Valvola deviatrice elettrica 3 vie SF25 Ottone <i>3-way switch valve SF25 Brass</i>
	<b>AC-0078</b>	Valvola di scarico termico <i>Thermal blowdown valve</i>
	<b>AC-0079</b>	Pozzetto sonda L=160 <i>Probe pocket L = 160</i>
	<b>AC-0080</b>	Pozzetto sonda L=200 <i>Probe pocket L = 200</i>
	<b>AC-0081</b>	Cerniera porta forno <i>Oven door hinge</i>
	<b>AC-0082</b>	Cerniera porte laterali termocucine (1pz) <i>Side door hinge for heating stove (1pc)</i>
	<b>AC-0083</b>	<b>Vetro temperato forno</b> serigrafato nero 420X218X4 (mod. Cuki 95 - Casadei) <i>Black silk-screened oven tempered glass 420X218X4 (mod. Cuki 95 - Casadei)</i>
	<b>AC-0025</b>	<b>Vetro temperato forno</b> serigrafato nero 350X218X4 (mod. Logan - Elsa) <i>Black silk-screened oven tempered glass 350X218X4 (mod. Logan)</i>
	<b>AC-0276</b>	<b>Griglia per forno</b> Termocucina mod. LOGAN 295X400 <i>Grill for cooker oven, mod. LOGAN 295X400</i>
	<b>AC-0099</b>	<b>Griglia per forno</b> Termocucina mod. CUKI 95 355X400 <i>Grill for cooker oven, mod. CUKI 95 355X400</i>
	<b>AC-0100</b>	<b>Supporti per griglia forno</b> Termocucina mod. CUKI 95 (la coppia) <i>Supports for oven grill of cooker, mod. CUKI 95 (the pair)</i>

	<b>AC-0091</b>	<b>Maniglia ottonata L=890</b> versione oro <i>Brass-plated handle L = 890 gold version</i>
	<b>AC-0092</b>	<b>Maniglia ottonata L=345</b> versione oro <i>Brass handle L = 345 gold version</i>
	<b>AC-0093</b>	<b>Maniglia ottonata L=890</b> versione cromo <i>Brass handle L = 890 chrome version</i>
	<b>AC-0094</b>	<b>Maniglia ottonata L=345</b> versione cromo <i>Brass-plated handle L = 345 chrome version</i>
	<b>AC-0095</b>	Maniglia coperchi Termocucina dorata <i>Golden heating cooker lid handle</i>
	<b>AC-0096</b>	Maniglia coperchi Termocucina cromata <i>Chrome-plated heating cooker lid handle</i>
	<b>AC-0098</b>	Isolante CLIMCOVER ROLL alu 1,2x14x2,5 al mq <i>CLIMCOVER ROLL insulation 1.2x14x2.5 per sq m</i>
	<b>AC-0101</b>	<b>Maniglia porta in ghisa</b> termocucine <i>Heat cooker cast iron door handle</i>
	<b>AC-0102</b>	Cerniere fix Coperchi Termocucina (1PZ) <i>Cover hilge (1pc)</i>
	<b>AC-0103</b>	<b>Pannello Inox</b> portastrumentazione CUKI 95 <i>CUKI 95 stainless steel instrument panel</i>
	<b>AC-0104</b>	<b>Pannello Inox</b> portastrumentazione CUKI 45 <i>CUKI 45 stainless steel instrument panel</i>
	<b>AC-0105</b>	<b>Attizzatoio c/molla cromato</b> <i>Poker with chromed spring</i>
	<b>AC-0305</b> <b>AC-0306</b>	<b>Padella forno CUKI 95, CASADEI</b> 343x410mm Oven Pan CUKI 95, CASADEI <b>Padella forno LOGAN</b> 278x410mm Oven Pan LOGAN



## **Njoy Stove**

**Via 1° Maggio 125 - 41056 Savignano sul Panaro (MO)**

**P.IVA 03625940360 - REA MODENA AL NR. 403933**

**CELL. +39 348 0436609**

**[www.njoystove.com](http://www.njoystove.com)**

**Email [info@njoystove.com](mailto:info@njoystove.com)**